

**MAM6070**



**Shenzhen Plot Electronic Co.,Ltd**

\_\_\_\_\_

\_\_\_\_\_





**MAM\*\*\***

/

<b>1.0</b>	<b>201707</b>			

..... 7

..... 22

..... 23

..... 23

..... 26

..... 27

..... 28



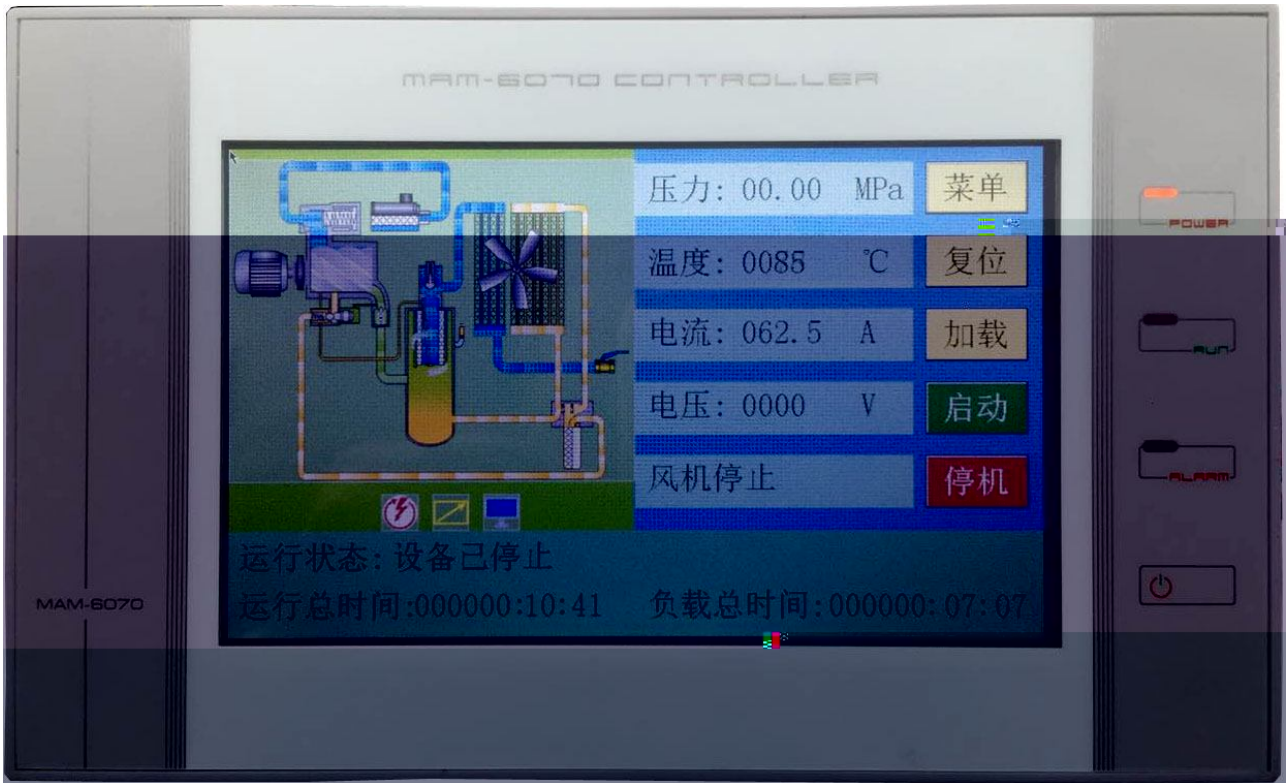

1.1.1

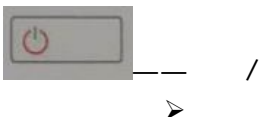



1



1

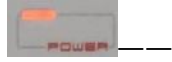

### MAM-6070



压力: 0.75MPa	菜单
温度: 100C	复位
电流: 100A	加载
电压: 220V	开机
风机: 运行	关机

状态: 自动加载运行

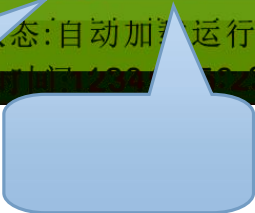

" "



" "

	0000H	
	0000H	
	0000H	
	0000H	
	0000H	
	00000000	
	0000V	
	A 000.0A B 000.0A C 000.0A	
	A 000.0A B 000.0A C 000.0A	
	0000 RPM	
	000.0 Hz	
	000.0 A	
	000.0 V	
	000.0 Kw	
	0000000.0KwH	
	0000000.0KwH	
	00.00MPa	
	0001	16
	0000	16
	000.0	
	0000 RPM	

	000. 0 Hz	
	000. 0 A	
	000. 0 V	
	000. 0 Kw	
	0000000. 0KwH	
	0000000. 0KwH	
	0000	
	0203	16
	0000	16
	000. 0	PI D
	0000-00-00	
	0000. 00. 00	
	0000. 00. 00	
1	00003FFF	1
	0K00000M0000	
2	FFFFFFFF_1	2
	1 2 3 4	
	1: 1 ;	
	2: 2 ;	
	3: 3 ;	
	4: 4 ;	
	16 15 14 13 12 11	
	16: 16 ;	
	15: 15 ;	
	14: 14 ;	
	13: 13 ;	
	12: 12 ;	
	11: 11 ;	
<b>U</b>	000000. 0 Kw	
	0000000. 0KwH	
	0000000. 0KwH	
<b>U</b>	000000. 0 Kw	
	0000000. 0KwH	

	0000000.0kWh	
--	--------------	--



MPa)	00.65	1. 2
MPa)	00.80	1. 2 " " " " "
	0080	
	0070	
	0010	
	0008	
	0006	
	0002	
	1200	
	0010	
	0100	

	0002	
	0001	
	0010	
	/	: " "
	/	: ,
	/	: :
	/ / / /	
	0001	
	/ /	MODBUS RTU 9600, 8E1; :
	MPa/PSI /BAR	MPa PSI BAR
		MPa PSI BAR
	/	
	****	

	1.2	
	1.2	

		" "
		1+ /10
		15
		" "
		" "
	****	
	/	
	/	
		" "
		" "
	KwH	
	KwH	

		/5
		/2 5

	0002	
	00. 63	
	00. 78	
	0010	
	0060	" " " "
	-	1. - ,
	-	2 " - "
	-	3 -
		1

1		/ / / / / / /
2		/ / / / / / /
3		/ / / / / / /
4		/ / / / / / /



	÷	÷ ÷ ÷
	÷	
	÷	
	÷	
	÷	

	00.65	" " " "
	00.80	" " " "
	00.70	" " " "
	00.00	" 00.00" ,
	00.00	" 00.00" ,

100

	00.70	
	060.0	
	022.0	
	1500	

		" "

/

/

/

		RS485
	/	1 2 3
		12
	06	
	30	
	0000000.0	
	001.0	
	/	
	0.50	" "
	0.60	" "
	0.65	" "
	0.70	" "
	0.00	" "
	0.00	" "
	0.00	" "
	200.0	
	180.0	
	160.0	
	150.0	
	150.0	
	150.0	
	150.0	

--	--	--



-20 +60

98%

$\pm 1$

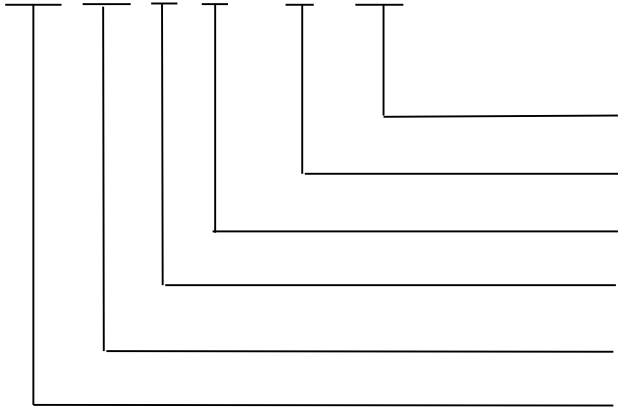

: ,



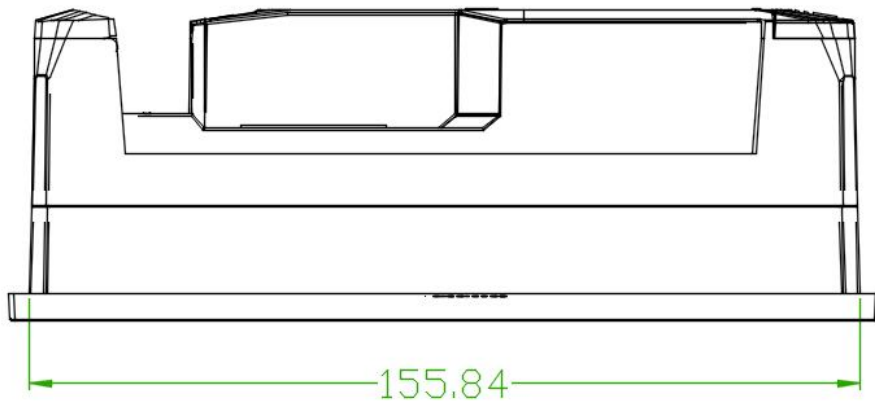
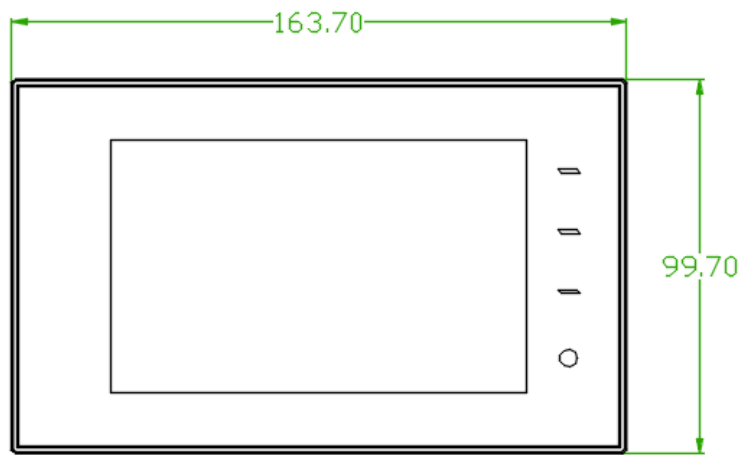
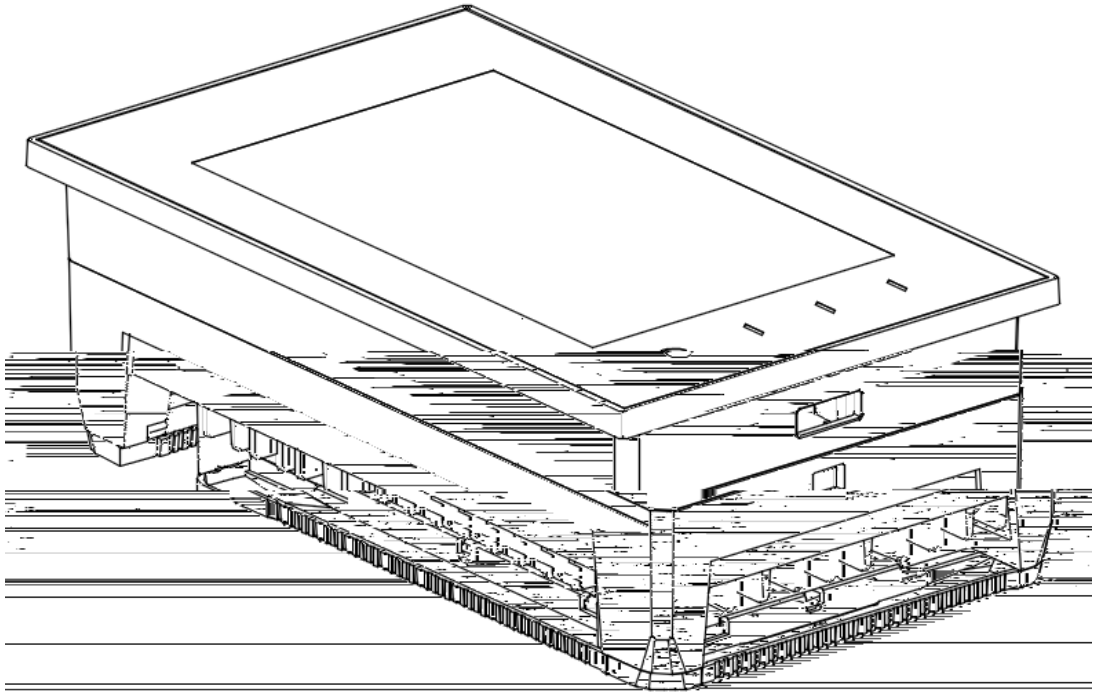

10

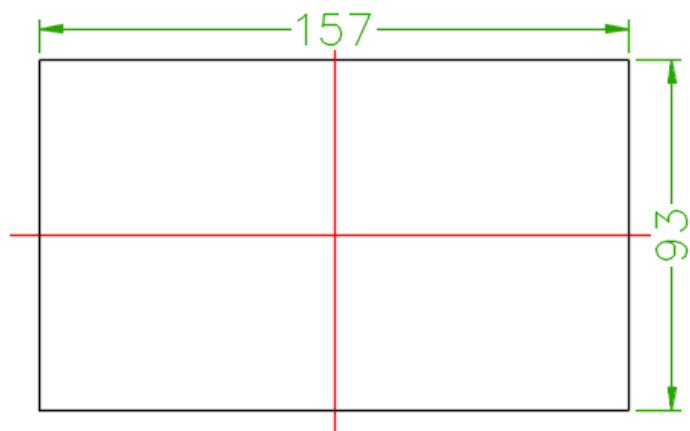
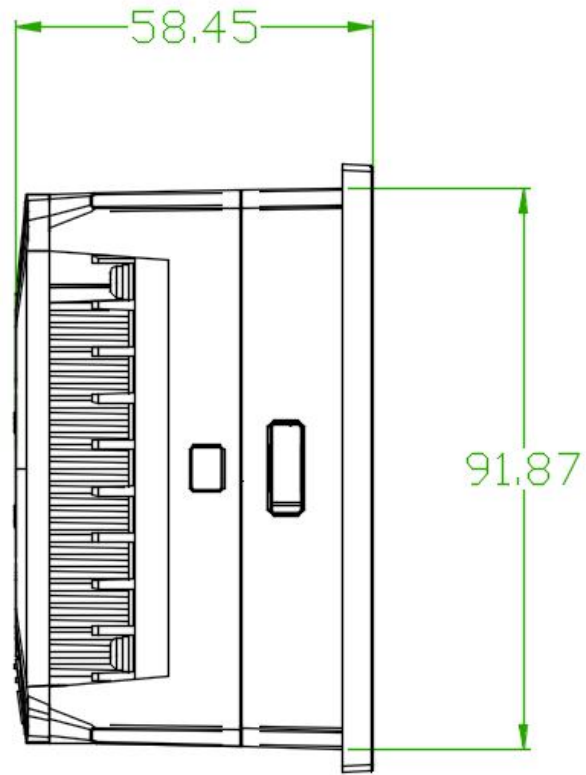



“ ”

" "

" "

" "

" "

" "

5.8 / 1

" "

“ ”

“ \*\* ”

	PT100	PT100
		+2

“ — ” “ ”





" " "

" " "

" "



18		19		20		8	7	6	
----	--	----	--	----	--	---	---	---	--

| 5 | 1 | 2 | 3 | 4 | | |      23      21 | 9 |

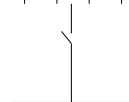

MAM6070

10.3

18		19		20		8	7	6	
----	--	----	--	----	--	---	---	---	--

\_\_\_\_\_

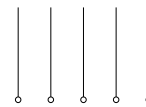

MAM6070





18 | | | 1

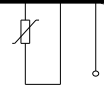

MAM6070

:

6080 6090 6070

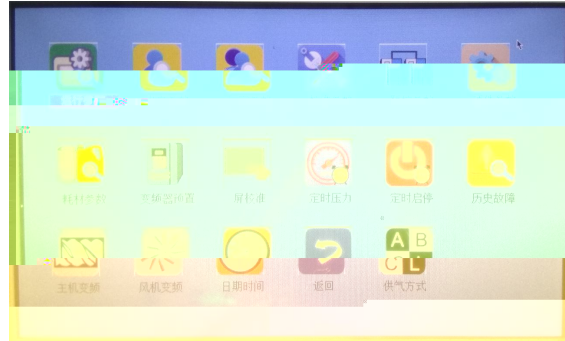

A:标准模式，空压机在额定负载下，以最节能方式运行。	当前模式: A
B:中速模式，空压机按设定的恒功率曲线运行，同时兼顾快速恒压。	恒压压力MPa: 00.65
C:高速模式，空压机按照设定的恒功率曲线运行，发挥全部性能供气。	最高频率Hz: 200.0
L:低用气量模式，空压机在额定负载下运行，低频运行时快速休眠。	模式选择
	A B
	C L
	返回

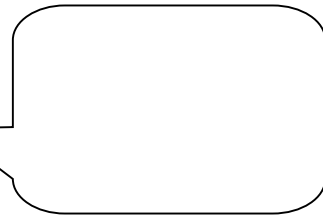

- 
- 
- 
-