

ITU7000 系列显控一体机

用户手册

苏州汇川技术有限公司
Suzhou Inovance Technology Co., Ltd.

地址：江苏省苏州市吴中区天鹅荡路52号

Ji 3W

@Ö 'ì,æ:

&O^

+B;,/ %j_ø:

/ %j@Ø5 " l

1æ #â4q/ %j

"¤(^#â4q

høFM" ((]`&

dī"÷_ø:

+B;,'9r

::<°_^_f

/ \ `] @C

/ \ `0;/ø

/ \ `9»3

l6@ _^_f

l6B]`<<

Nø/Q7\$RÀ

c %g" c %üNöå

d!#âj`<<

S N 'T

'ÛÖ`<<

*B"÷IR¤

jK3W

]°7'< %`

eT"÷_Ša,#â4q

; &E" 917



@Ö Ì,æ:

" Fl;C,æ:

Fl;C6B; hAð+42 @H1B6 ;/TE"p jW%n'œ m#Hziÿ& ;C&+

;,al9 XY#];CO_Að+42 @H1B6 ;/TE"p jW%n'œ6B; tO;*R—;,%n'œ"fki_%o'ætO"ü#V'W#N(
")»" 3 8`Ui8Z6 l- &8 l#i9; ISý_Ö02w" 3 "æü#V3d3 #l8fl m

#¶;C3`Nw m

")H< ,æ:

INOVANCE 汇川技术 :1Að+42 @H1B6 ;/TE"p jW%n'œÌ%uTV%n'œJ

@0%)H< t0;9 <c7ÖJ %x"×6B;)H< 6 @0%)H< t0I2(UiJ 6B; "»6ç mVçO-" 9»;*
R—"fki7 ;Cl2" Uib°JiJ # l)cä")H< t00 #¶/·%x6B; T J ;C&+ m

" %Oa(,æ:

I2" "¤(6 ;/" 9fl;9t l/) t0;9 <cJ % /"æTÿ" / jL"¤(" / %jJøO't09n_ü
]É mVç/Y+)\$P1itO_ü"æ jL"¤("9%" m

"¤("IR¤d'6 J % /"Út04W" 'É\Nd!Kæm

" %u" 2 3 FjJ - H

;"¤(t,(-d eT"-t-J /Y9@ l# l) l3 Sp2 d|/ 3U+1J @Ö Ì@Ö`] @C m

" /œ"»(ZJ] @C

;"9 <c6BO_J "¤(PüRài%C_%%(<<J " " »(ZcâN8`#] m%x8`#]3`l d|/ ;,9 <cJ Jø
%u_ø: tOfz&-:1/ %j'ì_k(L7ÖM; ml2" %y- Jø%u+œ_t'ìR—n tO(<<"»(Z'æ"æä];;"¤
(PüRàl lÖpt02wd %O'æTÿ] 'sjp m

" 7]"/ # l);;"¤(

?cLoJ c× IS`/Y l\`eT l/ \ ` l' _Ül8`#](Ri6f:1"¤(/%j l?c29c×NJ &07Ö03`
l #p_`C_%%J G° ;a"t03`l d|3<;9 <cJ Jø%u7ÖM;câN8`#] m





€ 7 " @H1P" Q Qv06m7Ñ 9»" RiL t0/ \`7 " @H1P" Q Qt0+) " Q Q% 8 Q#W,06M% m



" #b#i,æ:

?c29# l)4`%" t0"¤(^Ó 9GjE6 7a+Pt0@H1P6 ;/7G# b#i; % J #b#i; &Et,"¤(^#b#i;
ü°]`_Sa,Wt- ma c_#b#i; t00 98'0Ri#ia>l) m

#b#i; % t0"æ 4`%•d'6 J "¤(^7a+Pt00 98'0Ri#ia>l) m

€ " 7 6M% ",J]"/ 8`#];,"¤(^t0d'6 J "¤(^7a+P m

€ DID l@5D ll6' 3 29t0d'6 J "¤(^7a+P m

€ O ;,"¤(^l)" ke?c29&iTÿt0d'6 J "¤(^7a+P m

€ a %ü"¤(^]"/ J # l)W *t0d'6 J "¤(^7a+P m

€ " 'æ6 & t,UiE7D /· l+1k ljb%ýt-*âQ!3 a|J "¤(^ ?!7a+P m

; %u; &Ea>l)7 Eh' /•Räÿ< %`_fO t0- ; -RR\$T0"æRR\$# %JJ 'i& - H m

_°R'#b#i_ø: _ü~]` u"¤(^#b#i'c v m



+ß;,/ %j_ø:

/ %j@05 " l

" / %j,æ:

+) / \ ` l8`#] lRl6f"¤(ˆ9lt0_ü%Jj ' 2wd|/ ;,/ %j@05 " l m
 "9#H£"»b(_- / %jt0+)/ \ ` l8`#](Rl6f"¤(ˆ9lt0_ü|3"¤(" < _,"ì6M% ",_ø
 : J 6B; / %j@05 " l m
 6M% ",J wP@05 wQ lWp_k(LwQ(wP'sjpwQ" l t02w" "äj6B2 d|/ J 6B; / %j" l t0
 'i#]"96B; / %j@05 " l J \g%G m
 ;,"¤(ˆ2 +)O'(_-f]"<<] @CJ G°, " # l)tO((& 'æTÿd'6 9GjEt0*â*d|/ Jø%u]" /
 3 Ó & iTÿ3 296 dī"÷7a+POJ" +)"¤(ˆa-eÖP_`W *i]J% m
 *äcäj`8`#]"¤(ˆ3 Ó `»b°/ %j" 9G la"¤7a-20Jt0@H1B0 " 6 6`ü#V@Ö a("ü m
 " / %jOJR¤/ "H



危

†'sjp ·\jM;- ; " 7]"/ 8`#]t0& /yüö|"¢6 "\$eÖ°#T#%/. m



警告

‡_k(L ·\jM;- ; " 7]"/ 8`#]t0& 'æTÿ/yüö|"¢6 "\$eÖ°#T#%/. m



注意

‡@05 - - ; " 7]"/ 8`#]t0& 'æTÿ/yüö 3°b°#T#%/-6 _- 7a+P m

_ü-f) #B0¢;7 'Y"æ k j 9lj ' t02w_ü&£3'0 ;6M% "¥RÚ RÉ)69 m

7'&8PÜRà_`_f9l



警告

¤ " i l6aö"æQ(4'\$]?)b l29]"#b6f l?c`cqOj%x"»6aö2 _`Sp+);,"¤("æ vÜ)" j9?b_`
 - 7a+PJ \`Sp - " l" (3 - Mü&"jW#N 2 _`Sp+);,"¤("æ vÜ
 ¤ +);,"¤("æ _`Sp wP9Gj£#b6f l6aöwO`b9?b" / %jJ 5 - ;;<°Mü&"t,- ;,"¤(" Tÿ<ÄL
 J c %g c %ü7'&8'<Ó i _ø9lt0cä' '<+ä','æTÿ# %ÜG-5 - Mü&"t-vÜ
 ¤ _ü&£3`_`f!ÿ")l)69N 2 t0+);,"¤(ˆÓ :@M; l7'&8 ldl_ ll6B OJ9Gj£9It0TÿLo#H)69
 PÜRà' %jvÜ
 ¤ Lo#H,"¤(ˆì%x":7'&8*j]iBj dl_-9Gj£" # d'6 _- & iTÿ3 29t0d %O"»b°#%/-6 _- 7a
 +P m
 ¤ # l)9l_ü O 2'l6Fj#T7\$]"¤(ˆeÖ_- ,ø m





注意

æ_ü +)j°8zki; " _^_f'æTÿ/ÿUö8~#](Z"»b°#%/·6 _^- 7a+PJ 3 %utO_üWfí_`_f6i\NeQ
 8~#]J 3 %utO((& i _âc %ü6 9GjE'æTÿ3 'Ó 9GvÜ
 æ_ü & 2B!) " 7'&8_- / %j8~#]J]°8zki; 3 %utO- Q(4'\$]?b3 %u m_üWfí_`_SpLm":3 %u
 ;e6i\N?dP]8~#]tO((& 'æTÿd'6 "\$eÖ"»b°#%/·6 _^- 7a+PvÜ
 æ_ü 0 ;;"^(i)#]'æTÿd'6 "\$eÖ"»b°#%/·6 _^- 7a+P6 PÜRàs]:OJeÖ(6\$§_k_ kM;:_^- m
 ü# l)FíNÍJ Lm"÷ 6 ;;<° i ;e`_feÖ J 6\$§_k_7 M;"æ/ "iJ 7'&8]°Ö_^- m

/ \ 9!



警告

æ_üPcLo/ \';;"^(tO;,"^(jW" /¥% # l)tO_üLo#B l)G°, O'(" 9 wP+β;:"9rvÖW.]"
 <<wQJ] @CvÜ
 æ_ü / \ " 3;L+; lj;%KJiO InB* l; : E"@ #T IX"@-6 T P O J +; (tO((& ; F D,'s
 jpVÜ
 æ_ü +)'æTÿÓ B*2\$&iDÉÚ 6 B 2\$3 -(J G°, ",# l);;"^(tO((& 'æTÿ/ÿUö^- % dī"^(
 l %, %β@5tO/ÿUö^- 7a+PvÜ
 æ_üLo#bB; RÅS 7\$-5e Fc*βcā7\$&2;,"^(" m- ; cā7\$;-~*tO'æTÿ# "m l i _d_l c %g6 c
 %ü#āø m



注意

æ_ü7 Eh;6M% 2B_†J \$'/YB*2\$W *i% / \';;"^(tO((& 'æTÿd'6 - \$ %OP:@M;9GjE m

eTRÀØ!



危

æ / \ ' leTRÀØ#]" tO_ü&E3'+)& 9f!%jdíl6B (cāNvüü %O2'16F·4 cāN7\$RÀ17ÖÖRÅS 7Ö
 -5tO((& /": /ÿUö6%ÿtO6 /ÿUö6aö7a+PvÜ
 æ_ü7 ;6M% 6Bc:†00 JiABI6B J eTRÀ7\$" " l)NÄ/Q" vÜ
 æ cāN[...] /U&¢1æ 7\$RÀØtO' # eØ_OR6 l6RÀ57 %g) . *% dītO"æO'Ó 9GjE lI6/Q%E":
 7a+P6 DID vÜ
 æ 7\$RÀ 6 (2 "ÖR<ÄätOLO#P1æ]l6' (7\$RÀNÖQJ #NSp+H?cLo9â_ôm((& 'æTÿ# 3 a|DI
 D 6 " 9G m



注意

æ "9d %O]°l6tO+)cā7\$;,"^(J l6B &OtO_üPj& 9fIl6B vÜ
 æ ;;"^(J c %gl6B :1 % \$ 7tO- ; 6B# 2 J l6B " +) % \$ 7 p t)% tO0 # "\$eÖra+P;,"^(
 (tO*ādtO_ü 9l<Ää¥7d3 l6B # 2 *j6B7Ö# J % \$l6B :1((N4/ m

cλN l#B%}9!

- t0# l);@?Ót"÷/ \ `j9DI, t-J 4`%• t06OTÿO _ÆPÿRà l;: *jcâ7\$&2# " SRRÝ6 " TVSR m

* / 0 7 " / \$ &@H1b6 ;/" 9fl/œ"¤(`(]L%µ9»<HcãN3 'Ó /) "æÔiB/ %j4) m3;DÉB_†4 ì9†:i9†"¤(`2w-ìRÉ# l); 9†"¤(`Fl; m



Oâ9;ct"¤,- vØ?Ól;(nr \ \ ZmOJt-# 3 a|" / %jJ nw&*F•4 t0'æ# _^- - " " / %j J c\NF•4 t0"™T 'æTÿ/ýUö?|"¤ leÔ%(` a"¤7a-2 m _ÿ\$<<d|3<- " " | vØ

æ -ìRÉ# l); 9†Fl;J ct"÷m- ; # l)J "¤(`Fl;," % 'Ú917 t06 T ;*Tÿ2 l); 9†Fl;J N 2 t0/É69dt'ÛSRRÝ9=%ýJ lÔp# , &¤ m

æ &8/ 2wRi7 Jø2 J #b6f7<9¿t,# - #G" jW" vØiSt;@?Ót"÷lj9DI, | 8 " ' | * 1 4 * % 4 l4 &`5!KæÿRà l2 l)b°pn _ l"99r7p&¤/'OJt-t0j9?bMü&"/Y\$'_ ^ - ",J 9 "÷:Û&24x5 ct"÷J L5+Pt02w#b6f"¤(` ISRRÝIPÿRà(7\$'át0j9?b%ÛG- ;*R—7 ;CJ _ii l2s6r l%g#¶ |@`k99r7p6 #â4q-2N m

æ ' _ÚRÔ_(<À&B; (/ %jJø%uJ 7\$'áì_`Sp m





dī"÷ø:



S 'ø	Nöä Mæ	Nöä< _.	Nöä&ïTÿ_ø:
	(1&"cλN	3 6 /	(1&"N{' ;:cλNtOI2 # %E"÷\$=7'&8tO 3 6 / 7 " 9tO # O /tOI2I)69N 2 7'&8
	\$]?bcλN	4 5 0 1	\$]?bN{' ;:cλNtOI2 # %E"÷\$=7'&8tO 4 5 0 17 " 9tO # O ' tOI2I)69N 2 7'&
F•4 7 M;Dp		1 0 8 & 3	REVt29"flvø@7!ÿ#T::# I6?c29
		3 6 /	S Vt29"flvøN{' ;:cλN?c29tOI2 # 7'&8tO # Ø"flto # O ' 'E Dn
		" - " 3 .	(L_k7 M;Dpt,REVtt-tOI2 . %E"÷\$=7'&8tO # O /9tO7 M;Dp"flvÛ# O ' '9 7 M;DpDntOI2I)69N 2 Ui/ "H7'&8(L_k7 M;Dp iæD'6 29"fl



S 'ø	Nõä Mæ	Nõä< _.	Nõä&Tÿ_ø:
	B*2\$#!5!*j #âøc %g	1 5 1 5 1 5 1 5 1 5 1 5 1 5 / \$ 1 5 " 1 5 #	l)" <ÄLN(' ;B*2\$toe,l) 1 5 6 1 5 #! 5!*j 1 5 _ 1 5 vø1 5 1 5 c %g?c; / \$vøN(#Z3 U to" l)câ7\$ 1 5 " 1 5 # vø %g%+1Nð
	l6::l6AB#â 'øc %g	\$ 5 " \$ 5 # \$ 5 " \$ 5 #	'æ& & \$a N ") Jø"¥ABl6::J l6AB'IS;Jø<ÄAL \$ 5 " \$ 5 #vøldZ l6AB" 5!*jc %ü l \$ 5 \$vøldZ l6AB" 5!*j%n%SNð \$ 5 \$ \$ 5 #vøldZ l6AB" 5!*jc %ü l \$ 5 \$vøldZ l6AB" 5!*j%n%SNð
	' & <ÄAL#â 'øc %g	1 1 1 " 1 1 1 #	l)" <ÄAL' & 1 1 1 1 vø _ d!dZ' & #!5!jc %g 1 " 1 # vø %ü & #!5!*j# l6l6B
	l6B c %g	7 * / 7 1 &	* / 7 7 vø6B c %gNøto" '< & ?ca\$; 1 &vø6B f+1
	3 4 d!#â Nõä	(/ % (/ % (/ %	að c %üNðld!#â+1
	9r/X#âøc %g	9 9 9 9 9 9 9 9	9 9 9 9 9 vøod!3 %ueö %g 9 9 9 9 vø1 5 \$c %gt0%~/" :od!3 % %gtöc 4 c %g 4 4vør/Xeö %g%n%SNð
	" Jøl6c %g	" l # l \$	l)" <ÄAL" Jø"¥AB " # \$J RÄ6' (Jø2
	6 4 #d!#âNð â	6 4 #	7\$'â< %"vø6 4 #) P T UtOl)" câ7\$ 6JÛ d!#âd&G v. . C Q Tt, NRÄS t-



S 'ø	Nðá Mæ	Nðá< _.	Nðá&Tý_ø:
	RŁl6*jc %ü	: _ : \$ " \$ # \$ \$ \$ % \$ & \$ \$ \$vø: _ : %n%SNð \$ %vø: _ : %n%SNð \$ &vø: _ : %n%SNð \$ 'vø: _ : %n%SNð	: _ : vøŁl6*jc %üNð \$ "vø: _ : %n%SNð \$ #vø: _ : %n%SNð \$ \$ \$vø: _ : %n%SNð \$ %vø: _ : %n%SNð \$ &vø: _ : %n%SNð \$ 'vø: _ : %n%SNð
	SRá	& U I F S / & 5	< %"æ+SR7š'á 3 + t0917 . .uid 2 "æ+SRd!#â
	4 * .'c7Ō□	4 * .	l)" (TVSR t,# l) - t- @Ōvø: * 5 6 5 * "\$ (* 5 6 & * FjTVSR&iTý
	4 %'c	5 '	l)" ct"÷IR□
	4d- %ü	3 &	" l69ItOI 7 _E7 i5UrüG-[r**j(,æcã%g4d - %ü _SpF•4



注意

" V U P 4 I P Qct"÷MkiJ \$ 0 . t0 \$ 0 . "9:@7'ly#T;:% díd!#NðátOI)69_ü eTSp m

+β;,'9r

_E"¤(^J :@M;]"<< IPüRä]"<<OJ% /"- " \j6BM;vŌ

:@M;]"<<	
O;/ø	t&
& cG	
"fl2š	
:@M;lŌVt	#NK 3kvT
T,%KB	- & %
T,%KDpO ()
:@M;P +	>*OP
PüRä]"<<	
\$ 1 6	" *Ÿ<8 () [



% 3 "	. # % % 3
' M B T I	. #
3 5 \$	917
]°8zOPP +	RÅæ l6jB3
& iTj] "<<	
c %gl6'	7 \$ 7 \$) [) [
c %g; -(l6AB	"
Nõã" "<<	
"æ+SR	")
"1'â	\$ 0 . t, 3 4 t- \$ 0 . t, 3 4 t- \$ 0 . t, 3 4 t-
6 4 #	")
4 %'c	917
RÔ]" "<<	
- ,đcVt	%,DqVt
- ,âP9	" # 4 1 \$1æ ,R9
3 /UO;/øt,/% nß-	N N N N
/ \ ; ; -(' 2\$	N N
- 3dO;/øt,/% nß Aò	N N N N N N
eÖ	L H
G°,]" "<<	
1æ]B*2\$	° °
/Y\$'B*2\$	° °
1æ]B 2\$	3) 3)t,9æ%,%ß-
%, 'v9»3	UiE7%, 'v
Ax6Ö	N
ki; j96fOJR▫	&Oki; * 1
_ _	
\$ & _ _	O'(



::<°_ ^ _f

/ \] @C

" / \ @05 " |

/ \ &OtO_üLo#P"(- " 9flI6F•4 m

œ _ü # >!+XJ - .ôINô/Q7 Ică7Ş*j7 X?6 'Ü&2%-%ýtOd %O7a+P;;"œ(^ m

œ _ü 6 "]t;;"œ(^tO((& 'æTÿ7a+P"œ(^ m

œ _ü l)c. -(& KœEQ(*B;;"œ(^tOd %O7a+PNô/Q m

œ "9d %O# l)G°, ", "œ(^l|dīBī@5d'6 % dī*j"÷29JtO+)/ \ "'œ(^&OtOk O ' \ 'O†%
jK2'J j9@5< O @Āœ(^ |dī/'O + cĀS OF",a9(m

" / \ G°,] @C

;;"œ(^+ °&2 °J B*2ŞW *i% N4/ 1æ]tOa c_œW *i'æTÿd'6) . **j"÷7a+P lcx
VN3 296 4)Tÿ" jT m- k +)Fz? +;(# l)tO_ÿ;;"œ(^7G)H("œ m

œ _üd %O+); 3;DÉ:<°71&"J G°, "/ \ ;;;"œ(^ m

œ ;;"œ(^2 / \ +)Aò2Şa c. ?iPtJ JÜÜ,tO*Y(j#F7 UīO ?iPtJ N(iBaāM... m

œ _üLo#P;"œ(^/ \ 9lc°M...3;2s6rRĀS (_^- tO# - vØYABI6B RĀI 1 - \$c %ü>!+X l
'Ú *j IRĒI6*jOJtO_^- J c %g(c %ŪRĀS e 3 l e,l)OPY?RĀS tO2wO OPY?RĀS -f
) 7Ş+1 m

œ ;;"œ(^&Okī; O'(* 1 J j96f]"/ tO'u3U/œJÜÜjki),AīA†#T9ItOA†#T" # B %gJÜ
;Ü% dī m

/ \ 'O;/ø

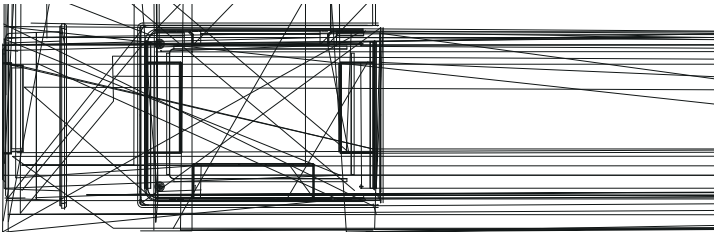

: @M; 0; /ø	"¤(¯)"<<		3 /UO;/ø2B, ‡		
	- 3d0;/ø /¾ nß Aò N N	/ \ `0;/ø 8) N N	8	N N) N N

/ \ `9»3

; Pü& "¤(¯917 / & . " / \ `< %" / \ `M; 5 *ÿ- " vø

6 "¤(¯9@%gki; 3 --J / \ `U", m

"ki; T, kiO / \ `eT" ‡j jKt-& &-'c%g"¤(¯, ð*ÿ(j- #¤J / \ `U% tO- " *ÿ
", 6BM; m

d ")i Q(/ \ `[...h - " *ÿ, 6BM; t07"WR6o& \$=vø

L H G D Nt, "æ" &

; ðd %Ok, ðÛdt- m

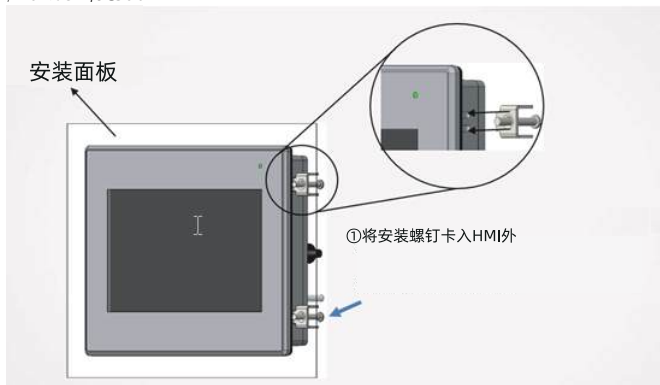

 **注意**

"9#p_`O'(/ & . " " J / `O]`W t06B; j "¤(¯7Ø J / \ `eT" ‡, @H1B% n'œeT" ‡tOS L vø
t-3'l # l)t0"] c, & l) & i Q(/ \ `[...h t02w" / \ `ki; J 30:ó\$ " Tÿa c,
o m



l6@ _ ^ _ f

l6B]" <<

Æ"α(ē.l)- 7\$ 7"¥ABc %gtO°R:]" <<9r7p- " \j6BM;

I Jī] " <<
c %gdldZ	
c %gcā7\$9»3	N NiBaâ< < 3 NŃ/Q'ò
c %gP +	917 " \$ 7
c %gl6' W *₁	" \$ 7 _ 7) [_) [
; -(c %gl6AB	"
c. ' #b6f	" 917
7	l6B
7	l6B
1 &	#b6f+1



Nð/Q7ŞRÀ

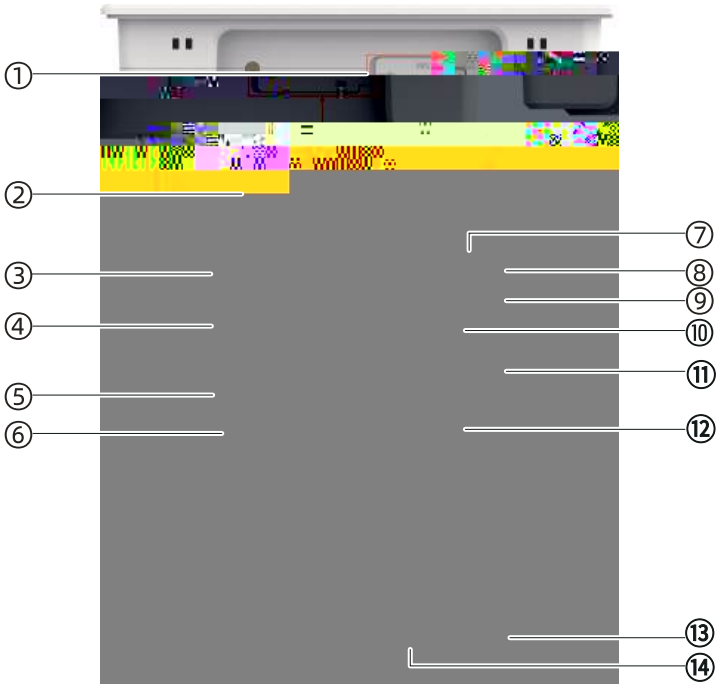

Nð/Q	_o:
	æ 4 * .vØ4 * .'c=y æ 5 'vØ5 ''c=y æ 3 'vØ #N7 hµ
	-*RÀŞ'á
	"¥AB" 5!*j#âœc %g7Ş'á
	1 5 6 1 5 B*2Ş#!5!*j#âœc %g7Ş'á
	l6AB+ ' & #!5!*j#âœc %g7Ş'á



Nð/Q	_Ø:
	" Jø16c %g7Ş'á
	\$ O . d!_-7Ş'á
	"¥ABI6B c %gNðá
	\$ O . d!_-7Ş'á
	\$ O . d!_-7Ş'á
	aô % *#âøc %g
	aôRt16*j#âøc %ü
	J %H"æ+SR7Ş'á
	6 4 # 7Ş'á

c %g" c %üNðá

9r/XeÖ %g

" 9 _ 9 +B;:]<<

I Jī]<<
c %gd!dZ9r	
c %gcâ7Ş9»3	N N< < 3 Nð/Q'ò
c %gP +	:od!3 %ueÖ
c %gd&G	t@) [
j M...9»3	%KT(j M...

" 9 _ 9 | 9 +B;:]<<

I Jī]<<
c %gd!dZ9r	
c %gcâ7Ş9»3	N N< < 3 Nð/Q'ò
c %gP +	917 1 5 \$c %gvÜ%~/":od!3 %ueÖ %g
c %g9»3	C + c %g
c %g"9 O /J l6jB	O "
c %g"9 O ' 'J l6jB	-(" L
c %gd&G	t@) [
j M...9»3	%KT(j M...



" l)697Ş'â

(Mæ	P +	& Tÿ
9	c %g	:od!3 %ueÖ %g
9	c %g	:od!3 %ueÖ %g
9	c %g	:od!3 %ueÖ %g
9	c %g	:od!3 %ueÖ %g
9	c %g	:od!3 %ueÖ %g
9	c %g	1 5 \$c %gt0%~/"3 %u9r/XeÖ
9	c %g	1 5 \$c %gt0%~/"3 %u9r/XeÖ
9	c %g	1 5 \$c %gt0%~/"3 %u9r/XeÖ
9	c %g	1 5 \$c %gt0%~/"3 %u9r/XeÖ
4 4	c %g	% *%n%SNö

" 7ŞRÀÿ

% "*" - dī_ - cã7Ş9ItO7"WR7Ş@Ö " vØ

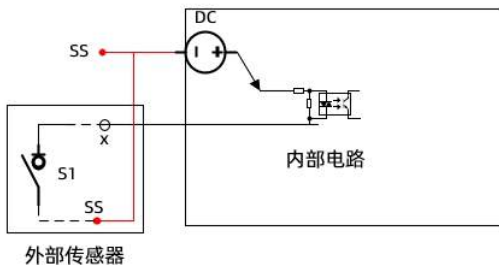

*ÿ :od!3 %ueÖ



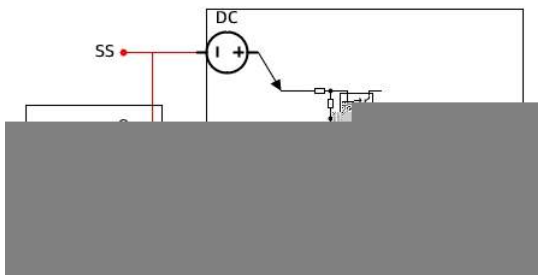

$$*y \quad 1 / 1C + c \%g\#!5!*j$$

RŁl6*jc %ü

" +β;,,]" <<

I Ji]" <<	
c %üldZ			
c %üP +		RŁl6*jc %ü	
c %ü"ääd6'		" \$ 7% \$ 7"æ%	
O / (~2 9lifß		N T"æ t,Lm"-ç~2 t-	
O ' ' (~2 9lifß		N T"æ t,Lm"-ç~2 t-	
; O a\$c		N " % \$	
; -(a\$c	jB4)a\$c	" \$ 7 " D*t, aät-vÜ" \$ " D*t, aät-	
	5l4)a\$c	% \$ 7 " D*t, aät-vÜ% \$ 7 D*t, aät-	
	/4)a\$c	" \$ 7tO 7 "	
j M...9»3		RŁl6*jj M...	
O (" O " ,?!)	

" l)697Ş'â

(Mæ	P +	&ıTÿ	- @Ø
:	c %ü	RŁl6*jc %ü	; -(" D"
:	c %ü	RŁl6*jc %ü	; -(" D"



(Mæ	P +	&jTÿ	- @Ø
\$ "	%n%sNð	: _ : %n%sNð	4=I6AB" 3 a c. "
:	c %ü	RłI6*jc %ü	;-(" D"
:	c %ü	RłI6*jc %ü	;-(" D"
\$ #	%n%sNð	: _ : %n%sNð	4=I6AB" 3 a c. "
:	c %ü	RłI6*jc %ü	;-(" D"
:	c %ü	RłI6*jc %ü	;-(" D"
\$ \$	%n%sNð	: _ : %n%sNð	4=I6AB" 3 a c. "
:	c %ü	RłI6*jc %ü	;-(" D"
:	c %ü	RłI6*jc %ü	;-(" D"
\$ %	%n%sNð	: _ : %n%sNð	4=I6AB" 3 a c. "
:	c %ü	RłI6*jc %ü	;-(" D"
:	c %ü	RłI6*jc %ü	;-(" D"
\$ &	%n%sNð	: _ : %n%sNð	4=I6AB" 3 a c. "
:	c %ü	RłI6*jc %ü	;-(" D"
:	c %ü	RłI6*jc %ü	;-(" D"
\$ '	%n%sNð	: _ : %n%sNð	4=I6AB" 3 a c. "

1 5 6 1 5 B*2Şe.<7

" +B;:]<<

I Jī]<<
c %gdlđZ	< eTvØ aô 1 5 1 5 t,%-/"t- nŕTvØ aô 1 5 1 5 t,%-/"t-
c %gcá7Ş9»3	N Niŕaâ< < 3 Nð/Q
#!5!*jP +	1 5 6 1 5
#!5!*j7ŞRÀ»3	"#R&8
B*2Ş<ÁLW *ı	1 5 1 5 vØ ° _ °
<ÁLP¿2Ş	BæŒ p
j M...9»3	" j M...



" l)697Ş'á

(Mæ	P +	&ıTÿ	- @Ø
1 5	c %g	O- d!dZ 1 5 1 5	c %g?c;
1 5	c %g	O- d!dZ 1 5 1 5	c %g?c;
1 5	c %g	O- d!dZ 1 5 1 5	c %g?c;
1 5	c %g	O- d!dZ 1 5 1 5	c %g?c;
1 5 "	c %g	1 5 _ 1 5 c %gl6B Nöt,a\$Nöt-	
1 5	c %g	O- d!dZ 1 5 1 5	c %g?c;"d l)" , 3;FI
1 5	c %g	O- d!dZ 1 5 1 5	c %g?c;"d l)" , 3;FI
1 5	c %g	O- d!dZ 1 5 1 5	c %g?c;"d l)" , 3;FI
1 5 #	c %g	1 5 _ 1 5 c %g%\$+1Nö	

' & e.<7

" +B;:]"<<

I Jī	J]"<<
c %gdldZ	
c %gcá7Ş9»3	N NiBaâ< 3 Nö/Q'ò
c %gl6ABW *ı	_ N "< %`l6AB+ ' & #!5!*j
e.<7Pç2Ş	BâeÖl p
j M...9»3	kej M...

" l)697Ş'á

(Mæ	P +	&ıTÿ
1 "	c %ü	' & #!5!*j# l6l6B
1	c %g	O- d!dZ' & #!5!*j c %gNö
1	c %g	O- d!dZ' & #!5!*j c %gNö
1 #	c %ü	' & #!5!*j# l6l6B
1	c %g	O- d!dZ' & #!5!*j c %gNö
1	c %g	O- d!dZ' & #!5!*j c %gNö



I Jī]“<<
Jø2 <ÅAL&iTÿ	917
j M...9»3	kej M...

“ l)69]“<<

(Mæ	P +	&iTÿJø2 %Tÿ



(Mæ	P +	&Tÿ
	d!#â	O- aô c %ÛÑð
(/ %	d!#â	O- aô d!#â+1

"æ+SR]" <<

" +B;," <<

I Jī] <<
c %ü!dZ	
c %Ûcã7\$9»3	< %""æ+SR7\$'ât,2'Dp 3 + t-
c %üP +	"æ+SR
c %ü!d&G	.
&Tÿ	917). *N 2 " c 1 - \$N 2 " c

" l)697\$'â

(Mæ	P +	&Tÿ
& U I F S / & 5	d!#â	"æ+SR7\$'ât07"WRa P 2'OPY?SRRÀcã 7\$

6 4 #]" <<

I Jī] <<
7\$'â3d3	6 4 # Z Q F "tOl)" - 7\$ 6JÛ
7\$'â< %"	6 4 #
d!_d&G	Bãa, 6 4 # 'Q_†
2'c Tÿ&	v" N "
Kiaô#b,f	917 Kiaô#b,f



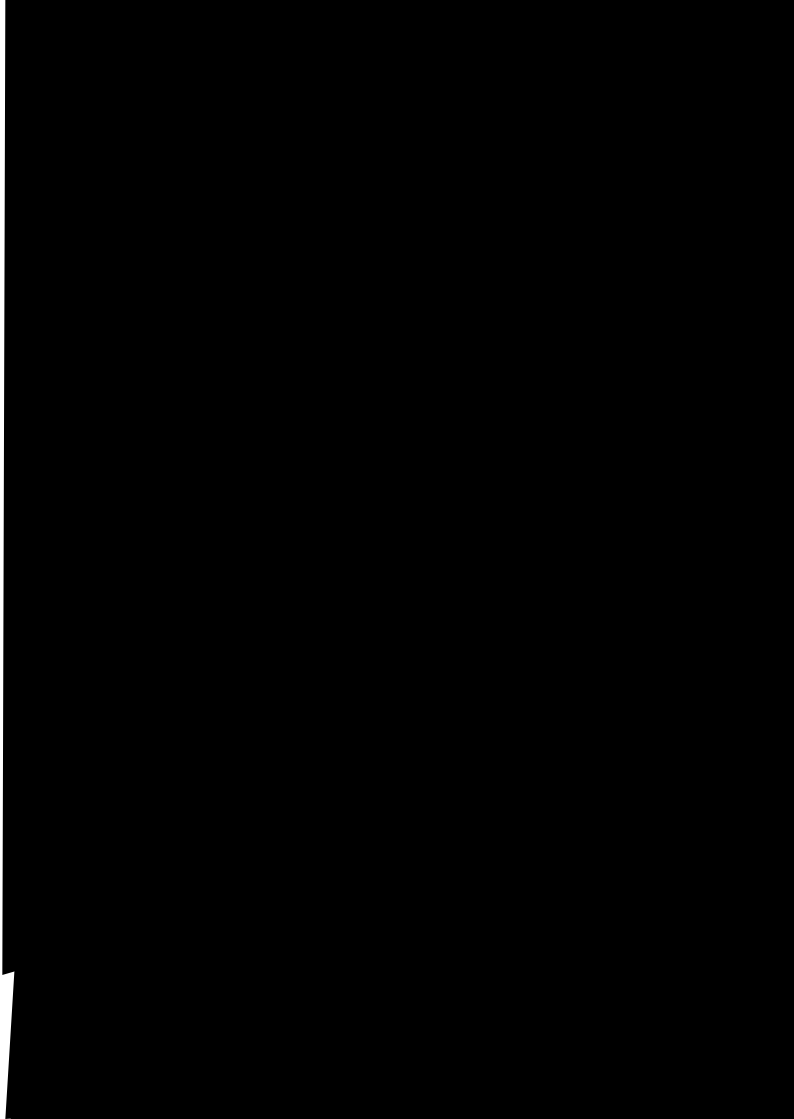

'ÜÖ-1+A	'ÜÖ "H	'ÜÖ-1+A	'ÜÖ "H
3	\$ 5 "J I6AB\$=	3	\$ 5 "J I6AB\$=
3	\$ 5 #J I6AB\$=	3	\$ 5 #J I6AB\$=
3	\$ 5 \$J I6AB\$=	3	\$ 5 \$J I6AB\$=
#	\$ 5 S;Jø< 3Û	#	\$ 5 S;Jø< 3Û
3	\$ 5 'ÛÖ	3	\$ 5 'ÛÖ
3	\$ 5 eÖN vÛ vØ N "tO vØ N "	3	\$ 5 eÖN vÛ vØ N "tO vØ N "
3	\$ 5 "Båª\$=	3	\$ 5 #Båª\$=
3	\$ 5 "Båª\$=	3	\$ 5 #Båª\$=
" JøI6B I6' " # \$<ÄLc %g			
3	S;Jø<ÄL< 3Û#N		"JøS;Jø
			#JøS;Jø
			\$JøS;Jø
			" #JøS;Jø
			" \$JøS;Jø
			# \$JøS;Jø
3	7 " #	3	7 " \$
3	7 # \$	3	Jø2 <ÄL
3	7 " #Båª\$=	3	7 " \$Båª\$=
3	7 # \$Båª\$=	3	7Jø2 Båª\$=
7 M;Dp(7 i5			
#	cXN ‡ 3 6 / .7 M;Dp7'&8tO # O /9ItO ‡ 3 6 / .7 M; Dp"flvÛ# O ' ' # 9ItO ‡ 3 6 / .7 M;DpDntO(2I) 69N 2 7'&8 m		(L_k ‡ " - .7 M;Dp7'&8tO # O /9ItO(L_kDp"flvÛ # O ' '9ItO(L_kDpDntO 12I)69N 2 7'&8 m
#	7 i5<ÄL7'&8tO ‡ 3 6 / .7 9ItO # O /	#	7 i5<ÄL7'&8tO ‡ 4 5 O 1 .7 9ItO # O /
. P E C V T / ' / Y *]			



'ÜÖ-1+A	'ÜÖ "H	'ÜÖ-1+A	'ÜÖ "H
3	. P E C V T7 "äC`A</`/Y*j vØ "æTSp ke vØMkieTSp	3	D P N. P E C V T`Q_†& 7d/`/Y *j vØ:NÚ ""NÚ vØ`NÚ " :NÚ %x"xs=vØä9J\$=
3	D P N. P E C V T`Q_†& 7d/`/Y*j vØ:NÚ ""NÚ vØ`NÚ " :NÚ %x"xs=vØä9J\$=	3	D P N. P E C V T`Q_†& 7d/`/Y *j vØ:NÚ ""NÚ vØ`NÚ " :NÚ %x"xs=vØä9J\$=
"1'äO_4)eTSp/`/Y*j			
3	vØ`/Y*jeTSp ke vØMkieTSp		
D P N O_4)eTSp			
3	"1'æTSp3 %u vØc29d!#â vØ#i9;eTSp vØo_#i9;	3	@^FzG vØ vØ vØ vØ vØ
3	\$]b#N vØ?]b#N"9 vØ?]b#N"9	3	9r7p#N vØr7p#N"9 vØr7p#N"9
3	<ln #N vØâ<ln vØH<ln vØw<ln	3	a 9l9liß _`Sp(; 9JtO- ; _E/`/Y*j\$= "9 tO& a 9l9liß"9IMkieTSp \$=t0; 9J\$="9 #N N Tt- m
D P N O_4)eTSp			
3	"1'æTSp3 %u vØc29d!#â vØ#i9;eTSp vØo_#i9;	3	@^FzG vØ vØ vØ vØ vØ







d 6°wP1æy 5 *B"≠IR□wQtO- " *ÿ6BM; m



'W%ÿwPW,'Ø1 - \$#â4qwQtOd 6°k] 'IR□J wP V Q H S B E FwQ9 " :tO'W%ÿwPLOW
6BM; m

固件升级

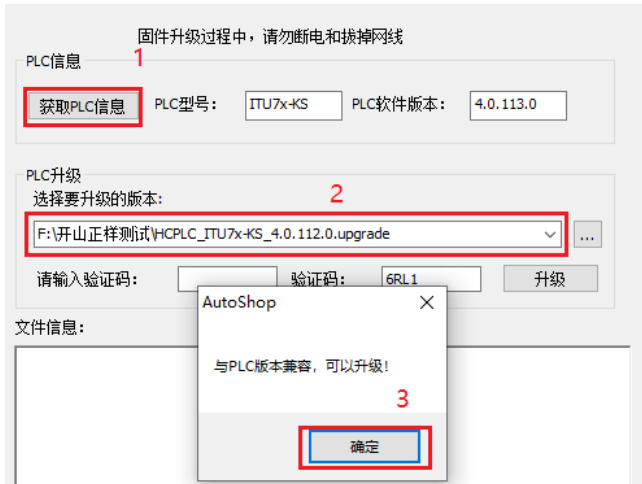

+)wP_üç %gn _L wQ<F" ,l% n _L tO- " *ÿ6BM; m

固件升级过程中，请勿断电和拔掉网线

PLC信息

获取PLC信息 PLC型号: ITU7x-KS PLC软件版本: 4.0.12.0

PLC升级

选择要升级的版本:

F:\HCPLC_ITU7x-KS_4.0.112.0.upgrade

请输入验证码: G9HD 验证码: G9HD **升级**

文件信息:

'W%ýwP'IRαwQtO3:%üwP" c câ2\$wQtO- " *ý6BM; m

固件升级过程中，请勿断电和拔掉网线

PLC信息

获取PLC信息 PLC型号: ITU7x-KS PLC软件版本: 4.0.1.0

PLC升级

选择要升级的版本:

F:\开山正

下载进度

22%

升级

请输入验证码:

文件信息:

正在下载中

'W%ýwP'IRα6 &ijwQ3:N ",J wPlo/ wQtO- " *ý6BM;tO'IRα/ 6 (_CE_^- O Ui&"eQ1 m

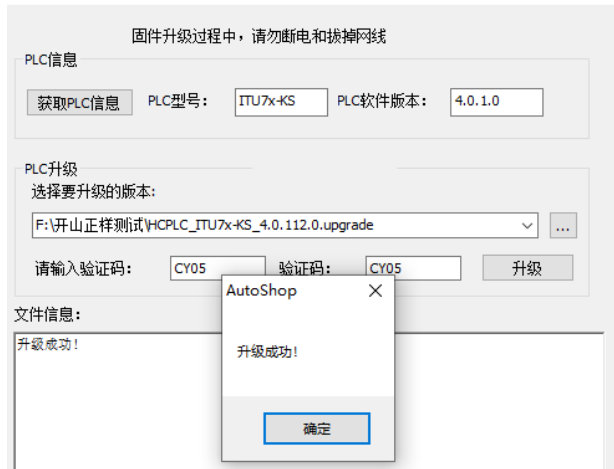

) . **B"÷IR□

_E"□(°917 6JÙ4 %'c6 T " #N;:"#M,9»3 'IR□) . **B"÷t0%y#T8`#]9»@Ö ?en"- " 6B
M; m

" 9»@Öwøilc. 6JÙ 4 %'c'IR□) . **B"÷

0 2';) . **B"÷ 6JÙ6 T 4 %'c7Ö%g_^- m

3 wP" c wQ7 hµ2Dq'Ú (t0'W%ý7 hµcã%g*B"÷IR□l{kitO- " *ÿ6BM; m

控制面板

返回



时间/时区



安全



背光



蜂鸣器



下载



恢复出厂



起始画面



语言



校准



屏保



网络



重启

控制面板

返回



时间/时区



安全



背光



蜂鸣器



下载



恢复出厂



起始画面



语言



校准



屏保



网络



重启

W%ýwP7 c _^- wQJ d l tOd ",6B70%gJ 7 c _^- t0- " *ÿ6BM; m

下载

返回

挂载设备： 导出编码选择：

SDCARD

升级：

PLC工程

HMI工程

d 6°IRαJ) . **B"⇒9 "≈wP G J S N X B S F [J QwQt0- " *ÿ6BM; m

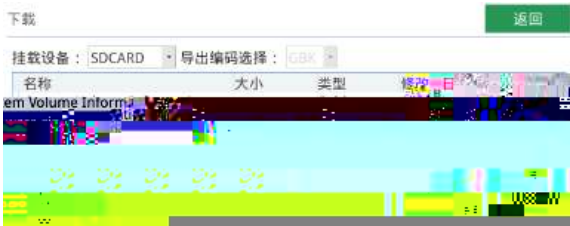

'W%ýwP) . *1a1 wQcã\N*ß"÷IRπtO3 'IRπ/ 6 (6M&"eQ1'u'æ# l)tO- " *ý6BM; m



" 9»@Ö vQ!c_wP * O P 5 P V D I 1 B EwQct"÷IRπ) . **ß"÷

O) . **ß"÷9 "÷wP G J S N X B S F [J QwQ9@%g" #N::wP * O P 5 P V D I 1 B Ew
*ý6BM; m



名称	修改日期	类型	大小
examples.7z	2022/3/3 14:16	7z Archive	8,343 KB
firmware.zip	2022/3/19 16:47	zip Archive	21,752 KB
firmware_tiny.zip	2022/3/19 16:48	zip Archive	6,591 KB
fontslim.dll	2022/3/3 14:16	应用程序扩展	1,819 KB
Graphics.7z	2022/3/3 14:16	7z Archive	12,559 KB
HCPLC_AP70X_41.20.10.0.upgrade	2022/3/3 14:16	UPGRADE 文件	24,393 KB
HistoryModule.dll	2022/3/3 14:16	应用程序扩展	183 KB
HMIAutoRun.exe	2022/3/19 16:34	应用程序	1,180 KB



W% 6U3 wP * O P 5 P V D I 1tBdEwQrS_Ö . :i9t*B"÷ 6 wQ+)3:%ü
 wP#|d :i9twQN 'ä,d 6°wP"æ+SRwQcâ7\$9»3 t0'W%ýwP:i9twQt03 'IRπ/ 6 (6M
 eQ1'u'æ# l)t0- " *y6BM; m



IP 传送-更新

? X

连接

以太网 10 . 45 . 122 . 19

密码:

0%

执行成功后关闭对话框

更新 取消

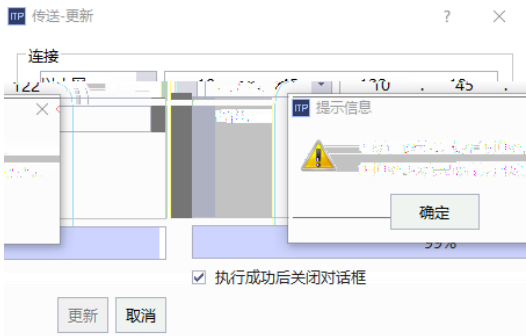

* O; *B"÷IRα

;"α(^917 dlc," #N:: * O P 5 P V D U19B3EcâN * O; *B"÷ 'IRαtO%y#T8" #]9»@Ö "

6BM; m
 O * O; J *B"÷wP * 5 6 C J OwQ9 "-9@Sp+)wP * O P 5 P V D I 1 B EwQJ /
 wP G J S N X B S F @ U J O Z [J QwQ" t,@0v0B"÷ (Mæ3'I "9wP * 5 6

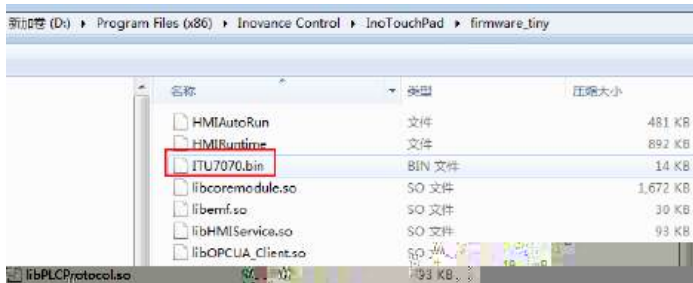

W% 6U3 wP * O P 5 P V D I 1 tB EwQ9S_Ö . :i9†*B"÷ 6 wQtO+)3:%Ü
 wP#Id :i9†wQN 'ä,d 6°wP"æ+SRwQcâ7S9»3 tO'W%yWP:i9†wQtO3 'IRα/ 6 (6M8
 eQ1'u'æ# l)tO- " *y6BM; m





MP 传送-更新

? X

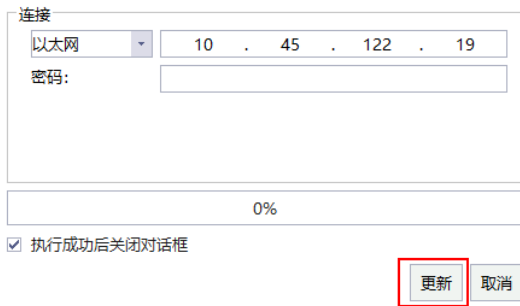

MP 传送-更新

? X

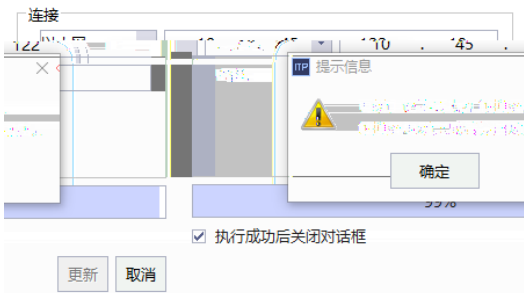

JK3W

]°7'< %"

;,"(+)# l)c,N ",t0- %üG-]°7"" Dv9Q6]°7'3 29t0_ü# l)]°7'<!%"N 2 ;ecã\N<! %" m

" cã%g]°7'<!%"N 2

d!c,PiRà_`SpWpWcã%gvØ) . *" I6(1&"(t03U0P2V7ÖM:wPi 7 cã%g_`Spki; wQ9t06M7 c 7 #POP2VJiUi:@M;wPeÑ@ca%g_`SplMkiwQtOc %gPiRà_`Sp/'L t03:%üPiRà_`SpWpW 'W%ýwP<!%"wQd l m

"]°7'<!%"%y#T8~#]

cã%g<!%">!3 (t00P2V1ç"]x%üG-!y")wP wQt0- " *ý6BM; m

l)]°7'0 6 T 6M7 D"]°wP wQJ ",iBtOD"]°6 &i(wP wQ# 7 *ýM;J Ofi-59»(Mü&" m

t,c T %"Lo+1+)wP wQ%K< J ",3"D"l'y" t03UJi< +)OP2V" Mü&"9t0eÖ _[E&"#] mt-

/ 6 D"J D"]°<!%"(t0wP wQ%K< # A -2t0?d9iD"]°OP2VN(J-- 'æd %üüç<!%"-2a*

%K< # eÖ†*ã&20P2V",-/t0eÖ - " *ý6BM; D"<!%"u'æ m

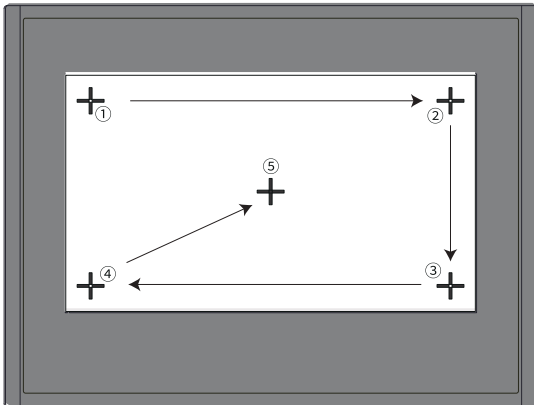

eT"÷_ša,#ã4q

eT"÷_ša2#ã4q_ü`T " \j6BM; m



(Mæ	+ 'ø	6 ;/] @C	_Sa,S L
I6AB" 5!*j \$ 5	" ,) ; ; ' ; " N "	R□ ' " N " , 7) [
	" ,) ; ; ' ; " N "	R□ ' " ; N " , 7) [
	" ,) ; ; ' ; " N "	R□ ' " ; N " , 7) [
	" ,) ; ; ' ; " N "	R□ ' " ; N " , 7) [
	" ,) ; ; ' ; " N "	R□ ' " ; N " , 7) [
	" ,) ; ; ' ; " N "	R□ ' " ; N " , 7) ["
I6AB" 5!*j \$ 5	" ,) ; ; ' ; " N "	R□ ' " ; N " , 7) [
	" ,) ; ; ' ; " N "	R□ ' " N " , 7) [
	" ,) ; ; ' ; " N "	R□ ' " ; N " , 7) [
	" ,) ; ; ' ; " N "	R□ ' " ; N " , 7) [
	" ,) ; ; ' ; " N "	R□ ' " ; N " , 7) [



; &£" 917

- ; 4"+)"# l)6 cX\Nc_N ";0 / %j" 9GtO6 8~#](Ri6f_^- J c_N ",dN&2j_l tO"
;ä " Jø%u9 <c";*Tÿ]t%µtO6 "i7G# " - M_6 ;/917 ; &£BldZtO"æo#P"J k @C3 &2'ì
9l(~2 m

æ BldZlÿw0%u@0wP@H1B6 ;/; &£wQ3°#æ%#n# 'øtOD"%ýwP;{Tÿ/£; wQtO'u'æ"<Ù 0 9
J "æ(~917 ; &£tO' 6î&ÿTÿ2 l)("ç I9Gj£- H 7 /ý l6M% aI9 W,'ØJ m



æ

